

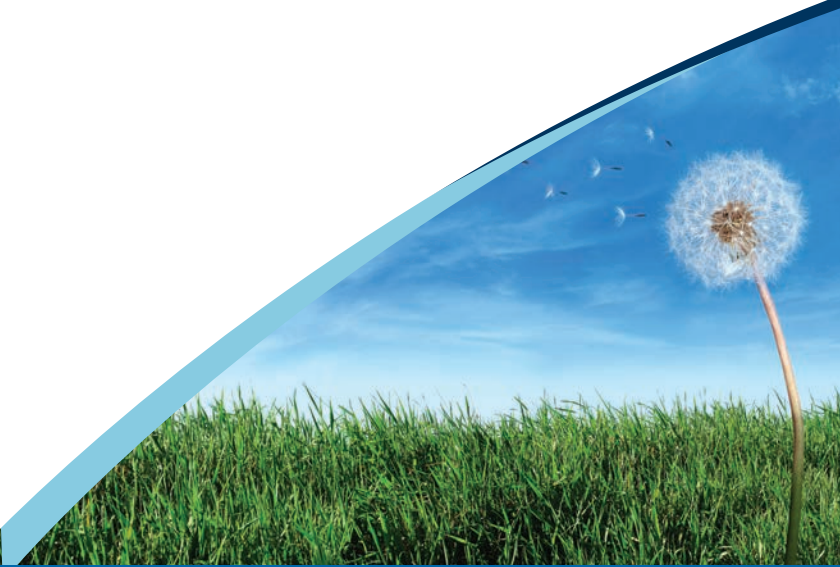

Inline Fans Options

Featuring TD-MIXVENT/TD-SILENT



The World's Leading Producer of Air Movement Products



TD_0116
January 2016

Table of Contents

Overview TD-MIXVENT & TD-SILENT Series.....	2
TD-MIXVENT & TD-SILENT Practical Installations.....	3
TD-MIXVENT General Details.....	4
TD-MIXVENT Installation & Maintenance	5
TD-MIXVENT Technical Specifications	6-7
TD-MIXVENT KIT-Bathroom Kits	8
TD-SILENT General Details	9
TD-SILENT Innovative Features	10
TD-SILENT Easy Installation.....	11
TD-SILENT Technical Specifications.....	12-13
TD-MIXVENT & TD-SILENT Accessories.....	14-18
Mixed Flow vs. Axial & Centrifugal Fans	19
PV-Powervent & SWF Sidewall	20

Overview TD-MIXVENT & TD-SILENT Series

Compact Size-TD Fans require minimum space

The S&P TD-MIXVENT & TD-SILENT series of in-line duct fans have been specially designed to maximize the airflow performance with minimal noise levels within the smallest and most compact of housing sizes. This makes the TD-MIXVENT & TD-SILENT series the ultimate solution for small to medium sized ventilation installations which require a high airflow to pressure ratio and occupy only the minimum space possible. Example: false ceiling voids, cabinets and many other limited space environments.

Easy to Install...fit and forget!

All the models in the TD-MIXVENT & TD-SILENT range have been designed with the professional contractor/engineer in mind. All models include a “removable body” feature that enables the motor-impeller assembly to be completely removed or replaced without the need to interfere with the attached ducting.



Multitude of features-high specification

All models within the TD-MIXVENT & TD-SILENT range incorporate a powerful mixed flow impeller and internal air vanes located at the discharge end of the fan housing. This impeller and guide vane combination provides a smooth laminar air flow which in turn minimizes turbulence and noise, and generates an **excellent air flow to pressure performance ratio**.

Description

All of the TD-fans include the combination of a powerful motor, factory installed, to a mixed flow impeller. This motor and impeller combination enables the TD-fans to deliver high airflow performances with minimum noise generation against high static pressures typically found in ducted ventilation systems. The unique design of the support brackets, allows the motor and impeller assembly to be fitted or removed without dismantling the adjacent ducting and therefore, facilitating any installation or maintenance. The internal aerodynamic design of the TD-MIXVENT & TD-SILENT fans enable the units to generate large air volumes and pressures with the minimum of in-duct or radiated noise. The TD-fans offer the ideal in-line duct fan solution for a wide range of HVAC ventilation applications.

TD-MIXVENT & TD-SILENT Practical Installations

The TD-MIXVENT & TD-SILENT system offers the most versatile installation range on the market, as a result of its multiple combinations; it can be used in a large number of small and mid-range ventilation installations.

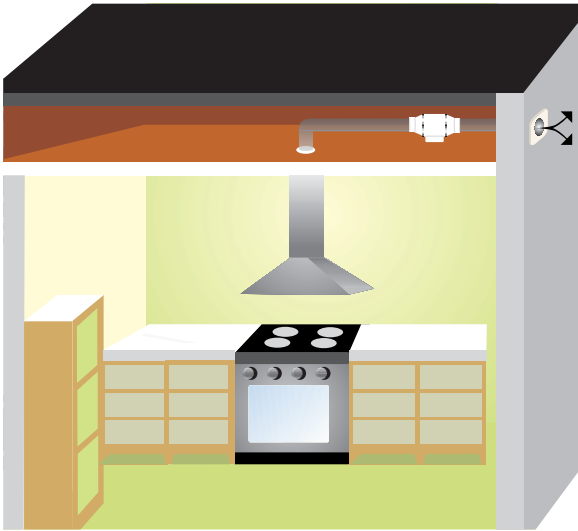

Domestic - Range Hood Exhaust



Commercial - Office

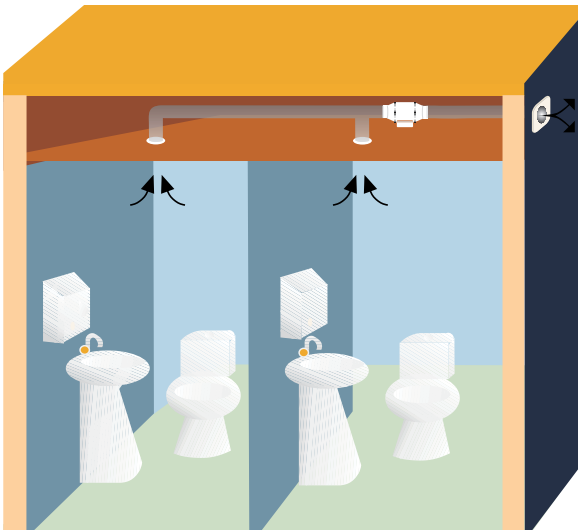

Industrial - Public Restroom

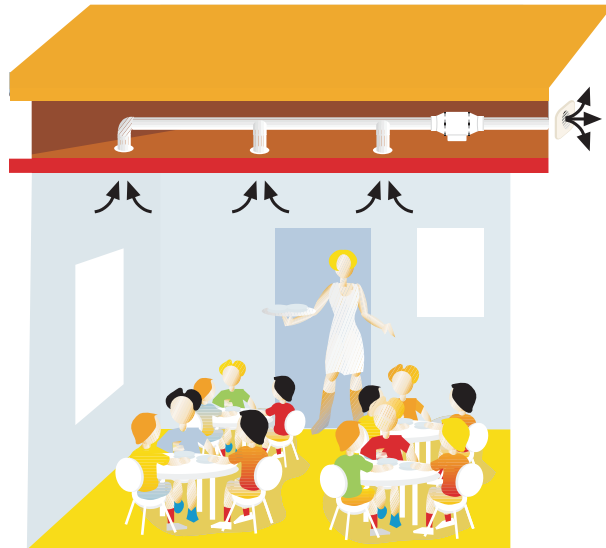

School - Dining Hall



Industrial - Locker Room

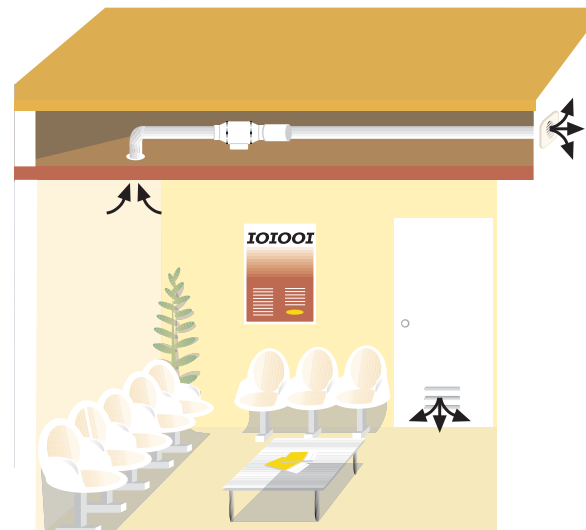

Health - Waiting Room

General Details of the TD-MIXVENT Range

S&P
Exclusive
Product



Low profile mixed flow fans, manufactured in plastic material (up to model 200) or in **galvanized steel** sheet protected with Epoxy paint (models 250, 315, 355, and 400), with external terminal box, removable motor-impeller assembly and adjustable single-phase motor, Class B, IP44.



Construction characteristics

	100	100x	125	150	200	250	315	355	400
Polypropylene housing	•	•	•	•	•				
Steel housing with epoxy coating						•	•	•	•
ABS fan blades	•	•	•	•	•				
Aluminum fan blades						•	•	•	•
Thermal link via fuse	•								
Thermal link with automatic reset		•	•	•	•	•	•	•	•
Permanently lubricated ball bearings	•	•	•	•	•	•	•	•	•

The extensive range of the TD-MIXVENT series makes it an effective solution for a wide range of residential and light commercial ventilation installations.

TD-MIXVENT Installation & Maintenance

Low Profile



The low profile of the fans in the TD-MIXVENT range makes them the ideal product for installations with low height limits, such as the case of suspended ceilings.

Easy to Install

1



Secure the support.

2



Make the connections.

3



Connect the ducts.

Flexibility in Location



The fans can be connected at any point along the ventilation duct: along the duct or at the end.

Easy Maintenance

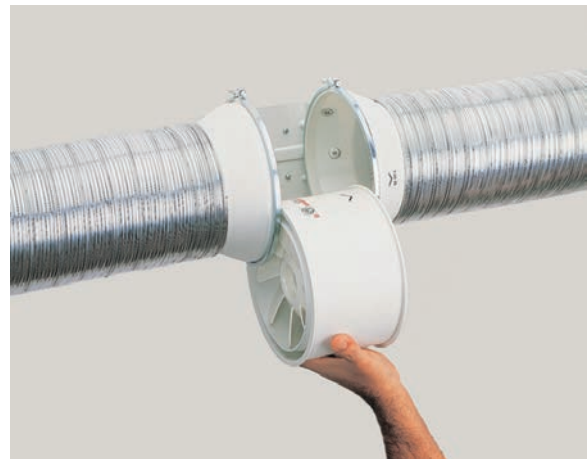

Removable body, for repair or cleaning, without the need to touch the ducts.



TD-MIXVENT Technical Specifications



Warranty

Five (5) year limited warranty.

Range

The TD-MIXVENT series consists of nine (9) nominal sized in-line fans. All models are specifically designed for direct connection in-line with industry standard diameter round ducting.

Construction

The TD-MIXVENT models 100, 100x, 125, 150, and 200 are manufactured in tough reinforced plastic, models 250, 315, 355, and 400 have a metal casing and are finished in a tough epoxy-polyester paint coating. The TD fan duct connection flanges are manufactured from reinforced plastic, except for models 200, 250, 315, 355, and 400 which are constructed from epoxy-polyester coated metal.

Impellers

The impeller blades for models 100, 100x, 125, 150 and 200 are molded in tough ABS plastic. Models 250, 315, 355, and 400 are metal.

Motors

Models 100, 100x and 125 :

- Single-phase, 120V 60Hz, shaded pole induction asynchronous motor in die cast aluminum. All motors include direct single speed connection and are also suitable for voltage speed control.
- Class II electrical insulation (model 100) & Class I (models 100x and 125)
- IP 44 Protection
- Class B Motor Insulation
- Safety auto reset Thermal Overload Protection (fuse type)
- Self-lubricating sleeve bearings.
- Suitable for working airstreams up to 104° F (40°C).

Models 150, 200, 250, 315, 355, and 400:

- Single-phase induction asynchronous motor, with permanent capacitor and external rotor constructed of die cast aluminum. Models 150, 200, 355 and 400 feature single speed, fully speed controllable motors. Models 250 and 315 include direct two speed connection motors and are also suitable for voltage speed control.
- Class I electrical insulation
- IP 44 Protection
- Thermal Overload Protection
- Class B Motor Insulation
- Sealed For Life, ball bearings
- Suitable for working airstreams up to 140° F (60°C).

Performance characteristics

Models 250 and 315 include a direct two speed motor connection.

Model	Nom. RPM	Volts	Max. Watts	Speed	CFM v Static Pressure (SP) Ins. WG							Max. SP	Max operating temp. (°F)	Wgt. (lbs)	Duct Dia. Ins.
					0"	0.125"	0.25"	0.375"	0.5"	0.75"	1.0"				
TD-100	2516	120	26	-	101	85	57	-	-	-	-	.4	104	2	4"
TD-100x	2096	120	33	-	135	113	90	53	-	-	-	.55	104	4.4	4"
TD-125	2146	120	38	-	197	168	133	86	22	-	-	.55	104	4.4	5"
TD-150	2289	120	65	-	293	273	250	227	206	131	35	1.15	140	4.4	6"
TD-200	2781	120	184	-	538	495	458	418	367	190	10	1.625	140	8.8	8"
TD-250	2400	115	162	LS	541	475	418	355	295	218	170	2.03	140	19.8	10"
	3200	115	241	HS	754	715	680	640	606	520	405	2.53	140	19.8	10"
TD-315	2000	115	208	LS	751	670	545	420	285	190	130	1.62	140	30.9	12.4"
	2500	115	335	HS	1050	990	932	850	770	600	420	2.95	140	30.9	12.4"
TD-355	1536	115	522	-	2090	2013	1935	1856	1777	1616	1326	1.1	140	43	14"
TD-400	1559	115	916	-	3127	3034	2938	2836	2735	2542	2303	1.2	140	78	16"

Performance certified is for installation Type D: Ducted Inlet, Ducted Outlet. Performance ratings do not include the effects of appurtenances.

LS= Low Speed
HS = High Speed



S&P USA certifies that all TD fan sizes shown herein are licensed to bear the AMCA Seal. The ratings shown are based on tests and procedures performed in accordance with AMCA Publication 211 and comply with the requirements of the AMCA Certified Ratings Program.



TD-100x, 125, 150, and 200 are ENERGY STAR® qualified.



The TD-MIXVENT Models 100, 100x and 150 are California Title 24 compliant and meet ASHRAE 62.2 when installed with a CVC and other TD models are compliant when installed with a 3 way switch and remotely mounted speed control.



TD 250 & 315 are UL listed for outdoor use.

Sound characteristics

Fan sound levels are measured in sones. At this time there are no sone level test standards available through HVI due to the fact that remote mounted fan noise levels are in proportion to the following: type of duct, length of duct, fan distance from the intake source and other miscellaneous factors. However, it is generally accepted that remote mounted venting is usually quieter than standard (in room) venting.

Dimensions (inches/mm)

Models 100-315

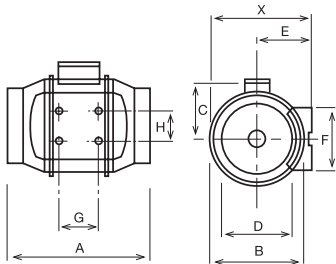

Model	X	A	B	C	D	E	F	G	H
TD-100	5 15/16 151	9 1/8 232	5 7/16 138	3 3/4 96	3 7/8 98	3 1/4 82	3 3/4 95	1 7/8 48	2 1/16 52
TD-100x	7 3/8 188	11 15/16 303	6 15/16 176	4 1/2 115	3 13/16 97	3 15/16 100	3 9/16 90	3 1/8 80	2 3/8 60
TD-125	7 3/8 188	10 3/16 258	6 15/16 176	4 1/2 115	4 13/16 123	3 15/16 100	3 9/16 90	3 1/8 80	2 3/8 60
TD-150	8 3/8 212	11 5/8 295	7 7/8 200	5 127	5 13/16 147	4 7/16 112	5 1/8 130	3 1/8 80	2 3/8 60
TD-200	9 3/16 233	11 7/8 302	8 9/16 217	5 9/16 141	7 13/16 198	4 7/8 124	5 1/2 140	3 15/16 100	3 11/16 94
TD-250	11 7/16 291	15 3/16 386	10 11/16 272	7 9/16 192	9 3/4 248	6 1/8 155	6 5/8 168	5 11/16 145	5 1/2 140
TD-315	14 356	17 11/16 450	13 1/4 336	8 13/16 224	12 5/16 312	7 3/8 188	8 1/4 210	7 3/16 182	7 178

Models 355 - 400

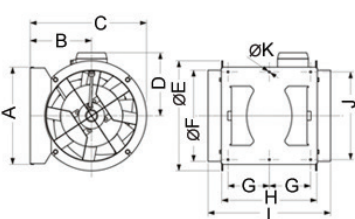

Model	A	B	C	D	E	F	G	H	I	J	K
TD-355	14 5/8 377	9 3/8 238	17 11/16 451	8 5/8 224	16 7/8 426	13 15/16 354	5 8/9 150	14 1/2 368	18 2/3 474	13 3/8 340	1/3 8.5
TD-400	16 407	9 4/5 249	19 3/8 492	10 1/2 267	19 1/8 487	15 5/7 399	6 2/7 160	16 3/4 425	21 5/8 547	14 4/7 370	1/3 8.5

TD-MIXVENT KIT Bathroom Kits



If the strongest, quietest, bathroom exhaust system is what you seek...look no further. S&P offers the perfect solution with the most options. The TD-MIXVENT fan kits provide all the hardware needed to complete a simple in-line ducted ventilation installation. The kit includes a powerful TD in-line fan and exterior and interior grilles (with or without lights). Available in both Standard Exhaust Kits, for venting a single location, and Deluxe Exhaust Kits, for venting multiple locations with one fan.

The TD-MIXVENT fan kit is the ideal solution for any simple in-line ducted fan installation. **All TD kits have standard 7-year warranty.**



Standard Exhaust Kits



KIT-TD100

- 1 TD100 exhaust fan
- 1 plastic round grille (PG-100)
- 1 exterior louvered grille (PER-100W)
- Integral mounting bracket

KIT-TD100x

- 1 TD100x exhaust fan
- 1 plastic round grille (PG-100)
- 1 exterior louvered grille (PER-100W)
- Integral mounting bracket

KIT-TD150

- 1 TD150 exhaust fan
- 1 plastic round grille (PG-150)
- 1 exterior louvered grille (PER-150W)
- Integral mounting bracket

Deluxe Exhaust Kits



KIT-TD150-DV

- 1 TD150 exhaust fan
- 2 plastic round grilles (PG-150)
- 1 exterior louvered grille (PER-150W)
- 1 Y-fitting (SY-6)
- Integral mounting bracket

IMPORTANT: If venting in a non-insulated attic space, or in a cold climate, insulated flexible duct is strongly recommended for condensation issues.

Lighted Standard Exhaust Kits



KIT-TD100XL

- 1 TD100x exhaust fan
- 1 Vent Light with LED Bulb (VLED-100)
- Integral mounting bracket

KIT-TD100XH

- 1 TD100x exhaust fan
- 1 Vent Light with Halogen Bulb (VLH-100)
- Integral mounting bracket

KIT-TD100XF

- 1 TD100x exhaust fan
- 1 Vent Light with Fluorescent Bulb (VLF-100)
- Integral mounting bracket

Lighted Deluxe Exhaust Kits



KIT-TD150L

- 1 TD150 exhaust fan
- 2 Vent Lights with LED Bulb (VLED-100)
- 1 Y-fitting (SY44-6)
- Integral mounting bracket

KIT-TD150H

- 1 TD150 exhaust fan
- 2 Vent Lights with Halogen Bulb (VLH-100)
- 1 Y-fitting (SY44-6)
- Integral mounting bracket

KIT-TD150F

- 1 TD150 exhaust fan
- 2 Vent Lights with Fluorescent Bulb (VLF-100)
- 1 Y-fitting (SY44-6)
- Integral mounting bracket

General Details of the TD-SILENT Range



As the name suggests these fans are extremely quiet, low profile “Mixed-flow” fans. Manufactured in plastic material with an external connection box, the body is easily dismantled with a full speed controllable, single speed motor. Sound waves are directed through the perforated inner skin and absorbed by a layer of sound-absorbent insulation. Plus the TD-SILENT is fitted with rubber gaskets on the inlet and outlet to absorb vibrations.

Construction characteristics

	125XS	150S	200S
Polypropylene housing	•	•	•
ABS fan blades	•	•	•
Thermal link with automatic reset	•	•	•
Permanently lubricated ball bearings	•	•	•

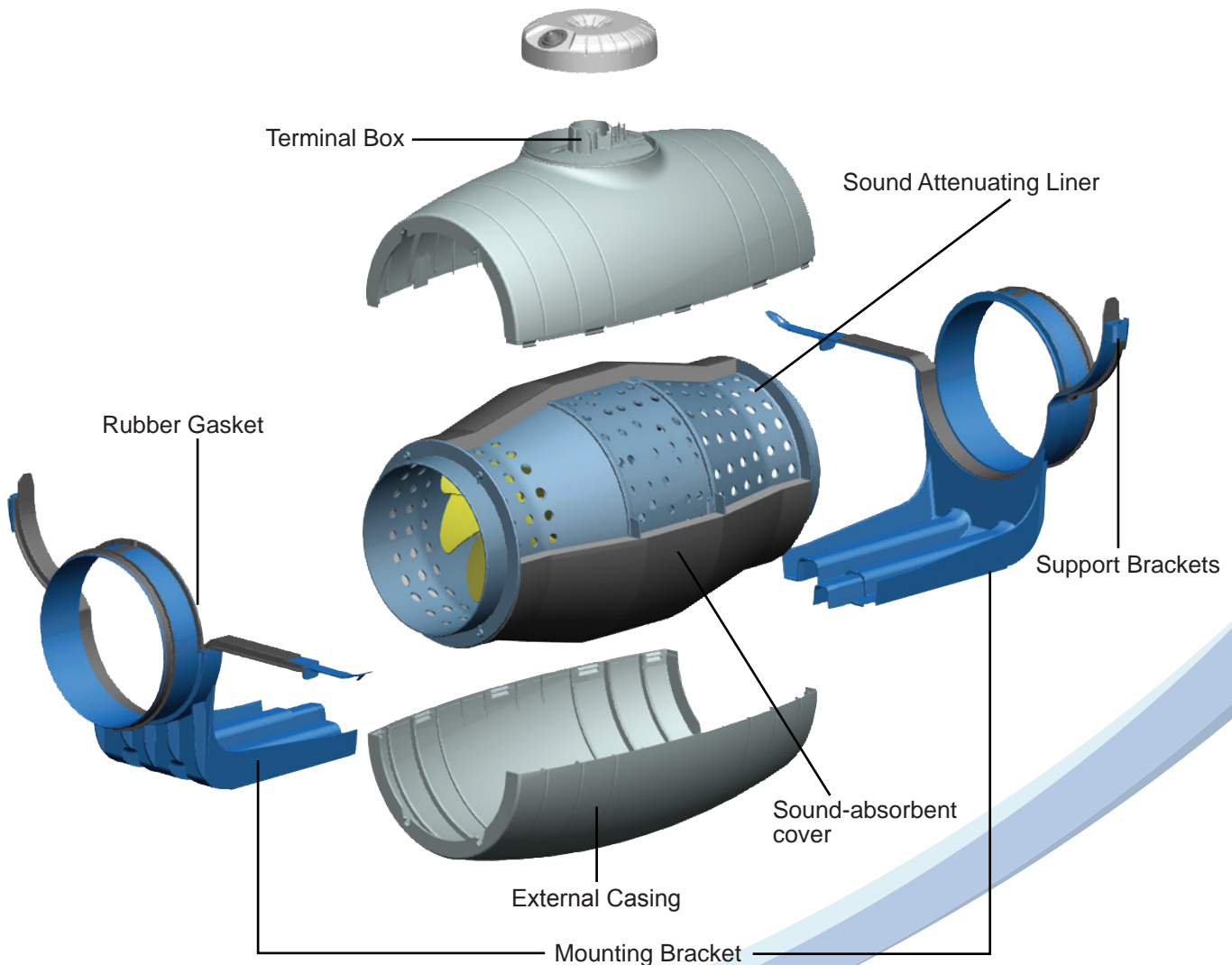

TD-SILENT Innovative Design Features

Low Profile



The low profile of the fans in the TD-SILENT range makes them the ideal product for installations with low height limits, such as the case of suspended ceilings.

Low Noise Levels



Sound waves produced inside the TD, are directed through the perforated inner skin and absorbed by the layer of sound-absorbent material.

Easy Maintenance



Bi-material support brackets, which in addition to simplifying installation, serve as joint seals.

Connection Box Rotates 360°

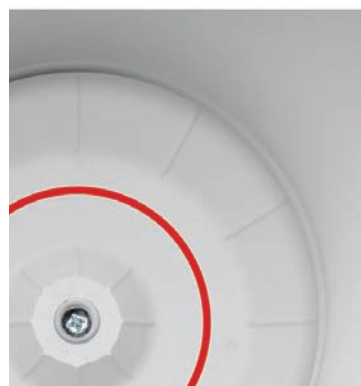

Connection box can be rotated 360°, to facilitate easy connection of the power cable.

Duct Air-Seals



Bi-material inlet and outlet incorporating a flexible washer to facilitate installation, absorb vibrations and provide a virtually **air-tight** seal.

Integral Mounting Bracket



Mounting bracket for installing on a wall or ceiling, incorporating twin-material support brackets for the motor section that absorbs vibration.

TD-SILENT Easy Installation

1



Loosen the clamps.

2



Open the clamps on both ends.

3



Remove the fan body.

4



Remove the terminal box lid.

5



Connect electrical supply.

6



Re-mount fan body by tightening the clamps.

TD-SILENT Technical Specifications



Warranty

Five (5) year limited warranty.

Range

The TD-SILENT consists of three (3) nominal sized in-line fans. All models are specifically designed for direct connection in-line with industry standard diameter round ducting.

Construction

The TD-SILENT models 125XS, 150S and 200S are manufactured in tough reinforced plastic. Sound waves are directed through the perforated inner skin and absorbed by a layer of sound-absorbent insulation. Plus the TD-SILENT is fitted with rubber gaskets on the inlet and outlet to absorb vibrations.

Impellers

The impeller blades are molded in tough ABS plastic.

Motors

Models 125XS:

Single-phase, 120V 60Hz, shaded pole induction asynchronous motor in die cast aluminum. All motors include direct single speed connection and are also suitable for voltage speed control.

- Class I electrical insulation
- IP 44 Protection
- Class B Motor Insulation
- Safety auto reset Thermal Overload Protection (fuse type)
- Self-lubricating sleeve bearings.
- Suitable for working airstreams up to 104° F (40°C).

Models 150S and 200S:

Single-phase induction asynchronous motor, with permanent capacitor and external rotor in die cast aluminum. All models include direct single speed connection and are also suitable for voltage speed control.

- Suitable for working airstreams up to 140° F (60°C).
- Class I electrical insulation
- IP 44 Protection
- Thermal Overload Protection
- Class B Motor Insulation
- Sealed For Life, ball bearings

Code Approval

- All models have been independently safety tested by Underwriters Laboratories, Inc. and are UL and cUL Listed.
- Independently tested for Airflow Performance.
- The TD product range is certified by the Home Ventilating Institute (HVI) for Air Performance.
- All models are ENERGY STAR® qualified.

Air Performance

Model	Duct Dia. Ins.	Nom. RPM	Volts	Max. Watts	CFM v Static Pressure (SP) Ins. WG							Max. SP	Max operating temp. (°F)	Wgt. (lbs)
					0"	0.125"	0.25"	0.375"	0.5"	0.75"	1.0"			
TD-125XS	5"	2500	120	36	203	175	138	84	33	-	-	0.6	104	11.9
TD-150S	6"	2700	120	65	333	315	286	271	257	178	77	1.2	140	13.2
TD-200S	8"	2200	120	122	530	503	472	443	415	349	204	1.2	140	19.2



The TD-SILENT Models 125XS and 150S are California Title 24 compliant and meet ASHRAE 62.2 when installed with a CVC and other TD models are compliant when installed with a 3 way switch and remotely mounted speed control.

Dimensions (inches)

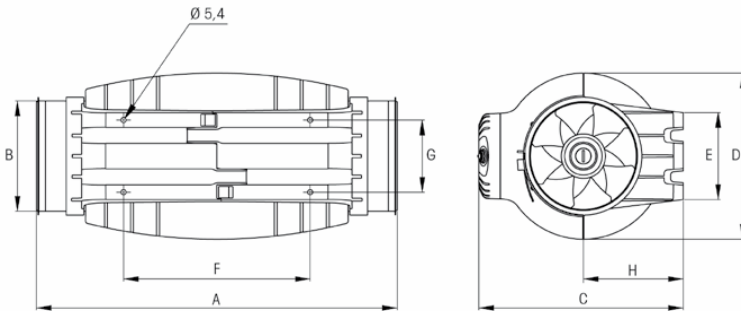

Model	A	B Ø	C	D Ø	E	F	G	H
TD-125XS	22 5/8	3 13/16	9 15/16	8 1/16	3 15/16	9 13/16	3 1/4	4 3/4
TD-150S	19 1/16	5 13/16	10 13/16	8 11/16	4 9/16	9 13/16	3 3/4	5 1/4
TD-200S	22 3/8	7 13/16	12 7/8	10 3/8	5 11/16	13 3/8	5 1/16	6 7/16

Bathroom Exhaust Controls - ASHRAE 62.2

CVC - Continuous Ventilation Control

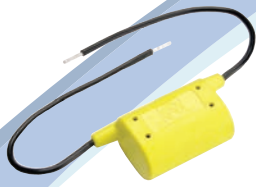

S&P's CVC allow a new or existing bath fan to run continuously on a low speed. In conjunction with an S&P TD fan a CVC will immediately improve the air quality in the home and reduce the damaging effects of moisture and mold.

The CVCs are designed to meet the requirements of ASHRAE 62.2 and the International Residential Code. In areas where ASHRAE 62.2 is not a requirement the CVC is still an economical choice to improve indoor air quality.

CVC Model	Fan Size	Application	Max. Flow	Continuous Flow @ .25"SP
CVC-100	100	Single Inlet	101 CFM	20 CFM
CVC-100x	100x	Single Inlet	135 CFM	20 CFM
CVC-150	150	Single Inlet	218 CFM	20 CFM
		Dual Inlet	293 CFM	40 CFM



Features

- Reduces remodeling costs, helps meet ASHRAE 62.2 requirements
- Perfect for homes, apartments, dorms, hotels and elderly housing
- Economical and easy to install in your existing wall box
- Works with most fan controls, i.e. motion sensors, timers, speed controllers.
- Undetectable, efficient and effective
- Operates with any standard switch
- No programming required
- 120V, 60 Hz, 3A Maximum

Dimensions in Inches (mm)

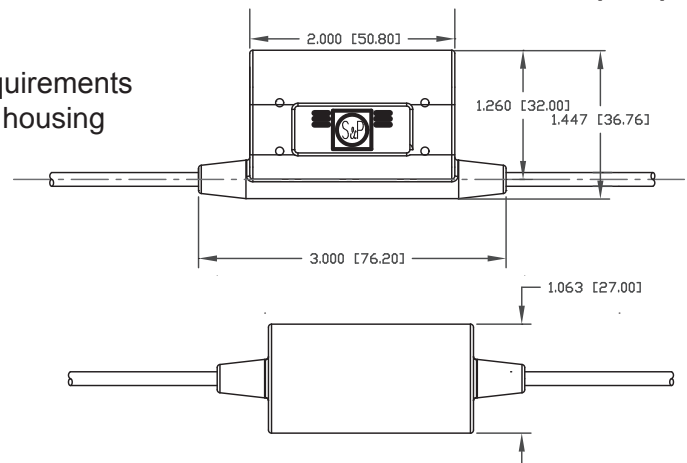

Easy Installation. . .



1 Attaches to any standard wall switch.

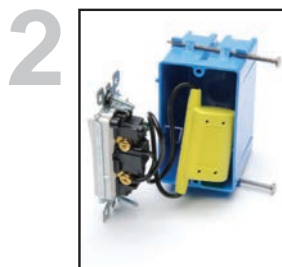

2 Simple 2 wire connection across the wall switch and fits into most standard wall/ junction boxes.

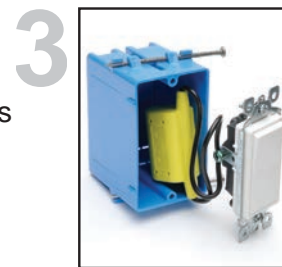

3 Completely installed in minutes!

FT622 - ASHRAE 62.2 Bath Fan Ventilation Control



The FT622 is designed to replace bathroom fan and light switches and provide both functions with one easy operation. The FT622 delivers a precise amount of ventilation, and is a simple solution to meet ASHRAE 62.2 in conjunction with an S&P fan.

FT247 - Programmable Fan Timer



S&P offers the FT247 with easy programming for your bathroom fan ventilation needs. Simply set what time you want the fan to turn on and off and what day or days you want the fan to run.

TD-MIXVENT & TD-SILENT Accessories



MCA

Backdraft dampers are installed at the fans' discharge. They prevent the entry of odors, air currents and prevent heat leaks when the exhauster is not in operation.

Model	Type TD
MCA-100	100
MCA-125	125
MCA-150	150
MCA-200	200
MCA-250	250
MCA-315	315

Dimensions (inches/mm)

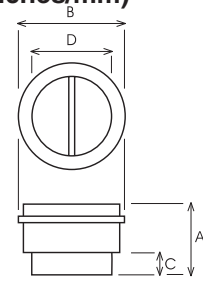

MCA-100-315

Model	A	B	C	D
MCA-100	4 3/16 107	4 3/8 111	1 1/4 31	3 11/16 94
MCA-125	4 3/16 107	5 3/8 136	1 1/4 31	4 11/16 119
MCA-150	4 3/4 121	6 7/16 163	1 3/8 35	5 13/16 147
MCA-200	5 3/16 131	8 7/16 214	1 3/8 35	7 3/4 197
MCA-250	6 3/16 164	10 3/8 264	1 5/8 42	9 3/4 248
MCA-315	8 1/16 205	13 330	1 15/16 50	12 5/16 312



MAR

Connections for rectangular ducts enable TD devices to be connected to a rectangular duct.

Model	Type TD	Nominal dim. of ducting L x H (in/mm)
MAR-100	100	9 x 6 224 x 140
MAR-125	125	9 x 6 224 x 140
MAR-150	150	11 x 7 280 x 180
MAR-200	200	12 x 8 315 x 200
MAR-250	250	16 x 10 400 x 250
MAR-315	315	20 x 12 500 x 315

Dimensions (inches/mm)

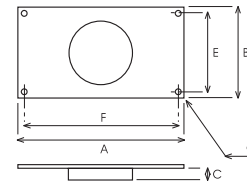

Model	A	B	C	E	F	G
MAR-100	10 3/8 264	7 1/16 180	1 5/16 33	6 5/16 160	9 5/8 244	3/8 9
MAR-125	10 3/8 264	7 1/16 180	1 5/16 33	6 5/16 160	9 5/8 244	3/8 9
MAR-150	12 5/8 320	8 11/16 220	1 7/16 37	7 7/8 200	11 13/16 300	3/8 9
MAR-200	14 355	9 7/16 240	1 7/16 37	8 11/16 220	13 3/16 335	3/8 9
MAR-250	17 5/16 440	11 7/16 290	1 5/8 42	10 5/8 270	16 9/16 420	3/8 9
MAR-315	21 1/4 540	14 355	2 1/16 52	14 355	20 1/2 520	3/8 9

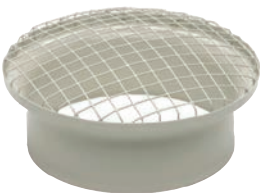

MRJ

Grilles fit on the suction and the discharge sides of the installation. They prevent the entry of foreign bodies which could damage the fan.

Model	Type TD
MRJ100	100
MRJ125	125
MRJ150	150
MRJ200	200
MRJ250	250
MRJ315	315



MBR

Flanges enable TD devices to connect in a series.

Model	Type TD
MBR-125	125
MBR-150	150
MBR-200	200
MBR-250	250

TD Bathroom Exhaust Grilles

Featuring Vent Lights and Premium Grilles

S&P's Grille Options give you the choice of seven (7) aesthetically pleasing grilles designed to match any bathroom decor. You can choose from our Vent Lights, Premium Grilles or Adjustable Grilles to fit your needs.

These grilles are designed to be used exclusively with one of S&P's TD remotely mounted inline for virtually silent bathroom ventilation. Inline fans give you the option to mount your grille over the shower, toilet, tub, or in multiple locations (dual vent).

With S&P's Grille Options the choice is yours!

Vent Lights

Available with LED Bulbs



S&P's new Vent Lights give you ventilation that is "Out-of-Sight and Out-of-Mind"! The Vent Lights appear to be a regular can light, and when combined with a remotely mounted fan, the noise and unsightly look of the traditional bathroom fan are gone! The Vent Lights are aesthetically pleasing grilles with lights that will match any bathroom decor.

Model	Description
VLED-100	Vent Light with PAR30 LED Bulb
VLH-100	Vent Light with PAR30 Halogen Bulb
VLF-100	Vent Light with Energy Star Rated Compact Fluorescent Bulb

Dimensions (inches)

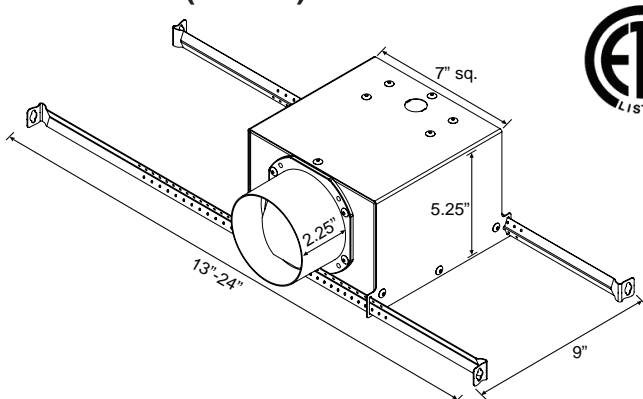

Features:

- Longer duct collar for 4" duct
- Extendable hanger bars up to 24"
- 7.5" grille
- Built-in backdraft damper
- 3 bulb options

Why Choose the Vent Light with LED Bulbs?

S&P's respect for the environment extends to its Vent Lights with the optional LED Bulb. The benefits to the LED Bulbs include:

- Built to last a minimum of 60,000 hours, plus the LED's use a fraction of the energy that a traditional incandescent or halogen lamp uses
- LED's contain no mercury so they are easy to dispose of, unlike other energy efficient bulbs
- The LED lamps run cool and are shock resistant, making them safer for use in your home

Premium Grilles

PG



S&P's premium grilles come standard with steel collars for easy mounting and installation.

Model	Description
PG-100	4" Plastic Grille with 4" Steel Collar
PG-150	6" Plastic Grille with 6" Steel Collar

Grille Dimensions (in inches)



Grille	Dia.	Height	Fits Duct Dia.	Fits Collars
PG-150G	8 1/8	1 5/8	6"	PG-150D
PG-100G	4 5/8	1 1/2	4"	PG-100D

Collar Dimensions (in inches)



Collar	Diameter	Length
PG-100D	3 3/4	3 1/4
PG-150D	5 3/4	4 5/8

PG Collar

Adjustable Grilles

BOR/BOC



Exhaust grilles for bathrooms, toilets and other small rooms. All models offer an adjustable central valve to regulate the airflow.

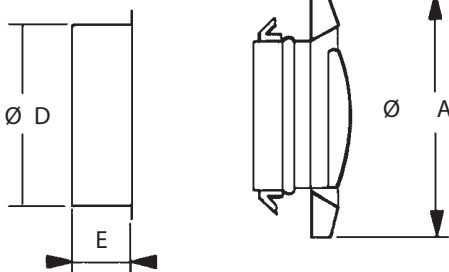

Model	A	D	E	Weight (lbs)
BOR/BOC-100	145	100	50	1
BOR/BOC-125	145	125	50	1
BOR/BOC-150	204	160	50	1
BOR/BOC-200	244	200	50	1

Additional general assembly accessories



BOR/BOC
Round plastic/metal
adjustable grille



MBR
Connection Flanges

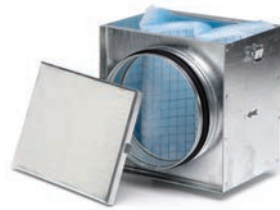

MFL
Filtering Box



PER-W
Plastic louver shutter



PER
High pressure aluminum
louver shutter



GRA
Aluminum exterior
fixed grilles



SR
Reducer



SY
Y sheet metal adapter



ID
Flexible round duct



SIL
Acoustic attenuators

Electrical accessories



EPBT
Electronic push button timer



SCS
Speed control slide type



SC
Speed control



5685-2W
2-Speed White Rocker
Wall Switch (High/Off/Low)

Mixed Flow Fans vs. Axial & Centrifugal Fans

Axial Fans

- Low noise levels
- High air volumes
- Very little static pressure capability*

Noise Level

High



Low

Air Volume

High

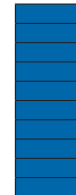

Low

Static Pressure

High



Low

Centrifugal Fans

- Higher noise levels
- Lower air volumes
- Very high static pressure capability*

High

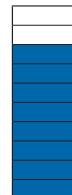

Low

High

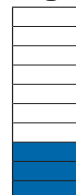

Low

High

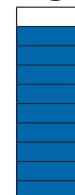

Low

Mixed Flow Fans**

- Low noise levels
- High air volumes
- Significant static pressure capability*

High



Low

High



Low

High



Low



Classic Centrifugal

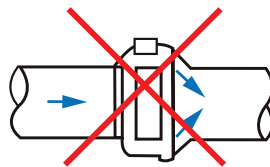

In-line Centrifugal

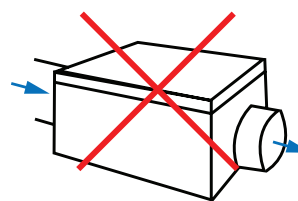

Ventilation Box

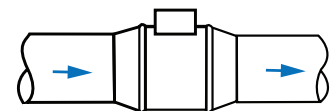

S&P's TD Fan

*Static pressure is the ability of the fan to overcome resistance such as long or complicated duct runs.

Mixed flow fans (TD series) offer the best of both axial and centrifugal fans and are suitable for most air movement applications. S&P's **TD-MIXVENT & TD-SILENT Series has all the benefits of a mixed flow fan, plus it requires minimal space and it is easy to install.

Also Available from S&P

PV-POWERVENT Fans



MODEL FEATURES

- Exhaust air up to 942 CFM with static pressure capabilities to 1.5" w.g.
- Galvanized steel casing with black backed enamel coating
- Pre-wired junction box
- Ideal for applications where space is limited
- Non-overloading backward inclined wheel for efficiency at higher static pressures
- AMCA Seal for Air Performance
- cULus Listed



S&P USA certifies that the PV range shown herein is licensed to bear the AMCA Seal. The ratings shown are based on tests and procedures performed in accordance with AMCA Publication 211 and comply with the requirements of the AMCA Certified Ratings Program.



*PV 150x and larger ENERGY STAR® qualified

Air Performance

Model No.	Nom. RPM	Volts	Max. Watts	CFM v Static Pressure (SP) Ins. WG										Max. SP	Duct Dia. Ins.
				0"	0.125"	0.25"	0.375"	0.5"	0.75"	1.0"	1.25"	1.5"			
PV-100	1400	115	57	108	100	92	85	78	66	52	33	18	1.70	4"	
PV-100x	2880	115	84	153	142	130	120	111	96	80	63	34	1.85	4"	
PV-125	2350	115	58	128	104	85	74	63	47	32	15	-	1.43	5"	
PV-125x	2745	115	85	206	190	170	153	135	110	88	62	33	1.77	5"	
PV-150	2750	115	78	245	205	177	157	129	93	59	-	-	1.20	6"	
PV-150x	2700	115	130	390	367	340	312	285	233	193	153	110	2.05	6"	
PV-200	3100	115	130	402	375	350	327	296	239	179	135	85	1.94	8"	
PV-200x	2930	115	180	544	515	485	446	415	360	312	273	230	2.64	8"	
PV-250	3000	115	170	568	533	502	471	440	370	312	263	221	2.61	10"	
PV-250x	3045	115	214	618	595	570	540	510	450	390	340	297	2.80	10"	
PV-315	2600	115	170	654	605	570	525	487	408	333	265	203	2.21	12.4"	
PV-315x	2650	115	370	942	905	859	811	762	622	508	440	390	3.90	12.4"	

Performance certified is for installation type D-Ducted inlet, Ducted outlet. Performance ratings do not include the effects of appurtenances (accessories). Speed (RPM or RPS) shown is nominal. Performance is based on actual speed of test.

SWF-SIDEWALL Fan



MODEL FEATURES

- Exhaust air up to 416 CFM with static pressure capabilities to 1.5" w.g.
- Galvanized steel casing with black backed enamel coating
- Pre-wired junction box
- Ideal for applications where space is limited
- Non-overloading backward inclined wheel for efficiency at higher static pressures
- cULus Listed

Air Performance

Model	RPM	Volts	Fre-quency	Current	Watts	CFM vs. Static Pressure (SP) Ins. WG									
						0"	0.125"	0.25"	0.375"	0.5"	0.75"	1.0"	1.25"	1.5"	
SWF-100	2200	120	60 Hz	0.52 A	57	119	106	92	78	64	44	26	-	-	
SWF-100X	2600	120	60 Hz	0.8 A	90	171	162	152	142	118	90	66	46	28	
SWF-150	2600	120	60 Hz	0.8 A	90	235	221	197	181	168	122	81	60	27	
SWF-150X	2800	120	60 Hz	1.0 A	115	354	332	310	287	266	230	192	147	96	
SWF-200	2800	120	60 Hz	1.0 A	115	416	395	368	341	324	287	233	184	132	



S&P USA Ventilation Systems, LLC S&P Canada Ventilation Products, Inc.

6393 Powers Avenue
Jacksonville, FL 32217
P. 904-731-4711 · F. 904-737-8322
www.spvg-northamerica.com

5600 Ambler Drive
Mississauga, ON L4W 2K9 - Canada
Tel. 416-744-1217 · Fax 416-744-0887
www.solerpalaucanada.com

